

Approval body for construction products  
and types of construction

Bautechnisches Prüfamt

An institution established by the Federal and  
Laender Governments



## European Technical Assessment

ETA-12/0553  
of 16 April 2018

English translation prepared by DIBt - Original version in German language

### General Part

Technical Assessment Body issuing the  
European Technical Assessment:

Deutsches Institut für Bautechnik

Trade name of the construction product

Friulsider Injection system KEM-UP + Vinylester  
for rebar connection

Product family  
to which the construction product belongs

Injection system for post-installed  
rebar connections

Manufacturer

Friulsider S.p.A.  
Via Trieste 1  
33048 SAN. GIOVANNI AL NATISONE  
ITALIEN

Manufacturing plant

Friulsider S.p.A., Plant 1 Germany

This European Technical Assessment  
contains

21 pages including 3 annexes which form an integral part  
of this assessment

This European Technical Assessment is  
issued in accordance with Regulation (EU)  
No 305/2011, on the basis of

EAD 330087-00-0601

The European Technical Assessment is issued by the Technical Assessment Body in its official language. Translations of this European Technical Assessment in other languages shall fully correspond to the original issued document and shall be identified as such.

Communication of this European Technical Assessment, including transmission by electronic means, shall be in full. However, partial reproduction may only be made with the written consent of the issuing Technical Assessment Body. Any partial reproduction shall be identified as such.

This European Technical Assessment may be withdrawn by the issuing Technical Assessment Body, in particular pursuant to information by the Commission in accordance with Article 25(3) of Regulation (EU) No 305/2011.

English translation prepared by DIBt

**Specific Part**

**1 Technical description of the product**

The subject of this European Technical Assessment is the post-installed connection, by anchoring or overlap connection joint, of reinforcing bars (rebars) in existing structures made of normal weight concrete, using the "Friulsider Injection system KEM-UP + Vinylester for rebar connection" in accordance with the regulations for reinforced concrete construction.

Reinforcing bars made of steel with a diameter  $\phi$  from 8 to 32 mm or the tension anchor ZA from sizes M12 to M24 according to Annex A and injection mortar KEM-UP + Vinylester are used for rebar connections. The rebar is placed into a drilled hole filled with injection mortar and is anchored via the bond between rebar, injection mortar and concrete.

The product description is given in Annex A.

**2 Specification of the intended use in accordance with the applicable European assessment Document**

The performances given in Section 3 are only valid if the anchor is used in compliance with the specifications and conditions given in Annex B.

The verifications and assessment methods on which this European Technical Assessment is based lead to the assumption of a working life of the rebar connection of at least 50 years. The indications given on the working life cannot be interpreted as a guarantee given by the producer, but are to be regarded only as a means for choosing the right products in relation to the expected economically reasonable working life of the works.

**3 Performance of the product and references to the methods used for its assessment**

**3.1 Mechanical resistance and stability (BWR 1)**

Essential characteristic	Performance
Amplification factor $\alpha_{lb}$ , Bond resistance $f_{bd}$	See Annex C 1

**3.2 Safety in case of fire (BWR 2)**

Essential characteristic	Performance
Reaction to fire	Rebar connections satisfy requirements for Class A1
Resistance to fire	See Annex C 2 and C 3

**4 Assessment and verification of constancy of performance (AVCP) system applied, with reference to its legal base**

In accordance with European Assessment Document EAD No. 330087-00-0601, the applicable European legal act is: [96/582/EC].

The system(s) to be applied is (are): 1

English translation prepared by DIBt

**5 Technical details necessary for the implementation of the AVCP system, as provided for in the applicable European Assessment Document**

Technical details necessary for the implementation of the AVCP system are laid down in the control plan deposited with Deutsches Institut für Bautechnik.

Issued in Berlin on 16 April 2018 by Deutsches Institut für Bautechnik

BD Dipl.-Ing. Andreas Kummerow  
Head of Department

*beglaubigt:*  
Baderschneider

### Installation post installed rebar

**Figure A1:** Overlapping joint for rebar connections of slabs and beams

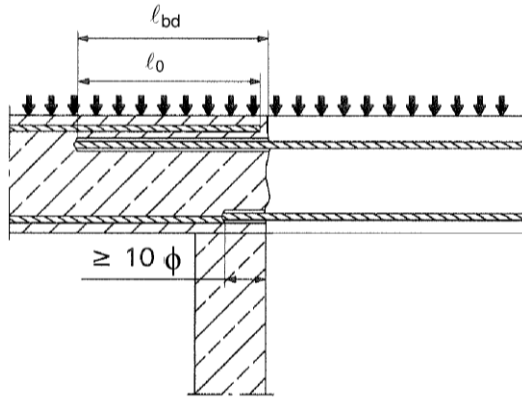

**Figure A2:** Overlapping joint at a foundation of a wall or column where the rebars are stressed in tension

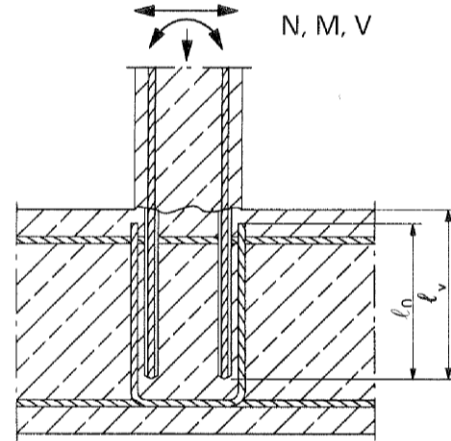

**Figure A3:** End anchoring of slabs or beams (e.g. designed as simply supported)

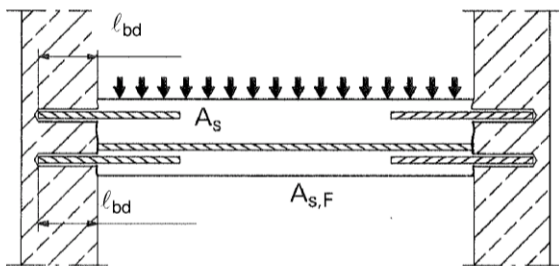

**Figure A4:** Rebar connection for components stressed primarily in compression. The rebars are stressed in compression

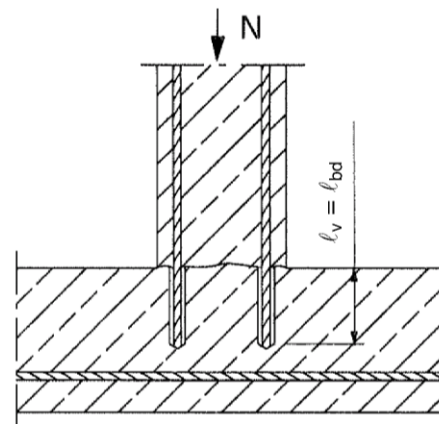

**Figure A5:** Anchoring of reinforcement to cover the line of acting tensile force

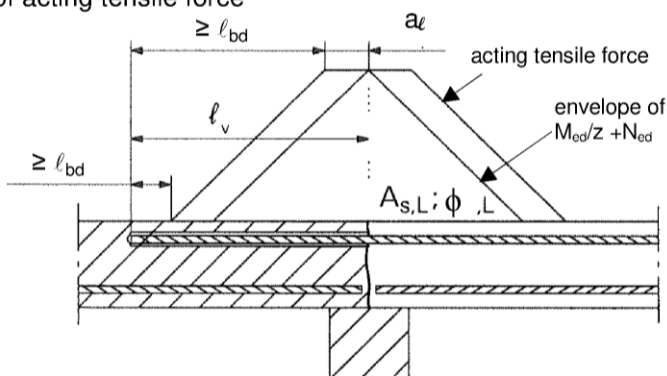

**Note to Figure A1 to A5:**

In the Figures no transverse reinforcement is plotted, the transverse reinforcement shall comply with EN 1992-1-1:2004+AC:2010.

Preparing of joints according to Annex B 2

Friulsider Injection System KEM-UP + Vinylester for rebar connection

**Product description**  
Installed condition and examples of use for rebars

**Annex A 1**

## Installation tension anchor ZA

**Figure A6:** Overlapping joint of a column stressed in bending to a foundation

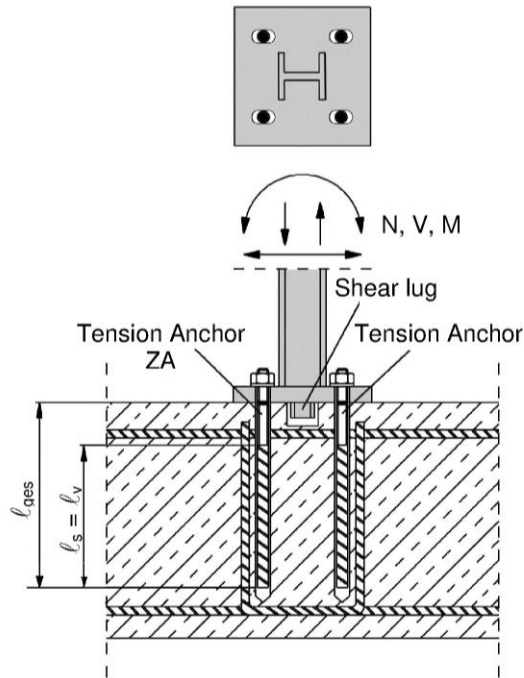

**Figure A7:** Overlap joint for the anchorage of barrier posts

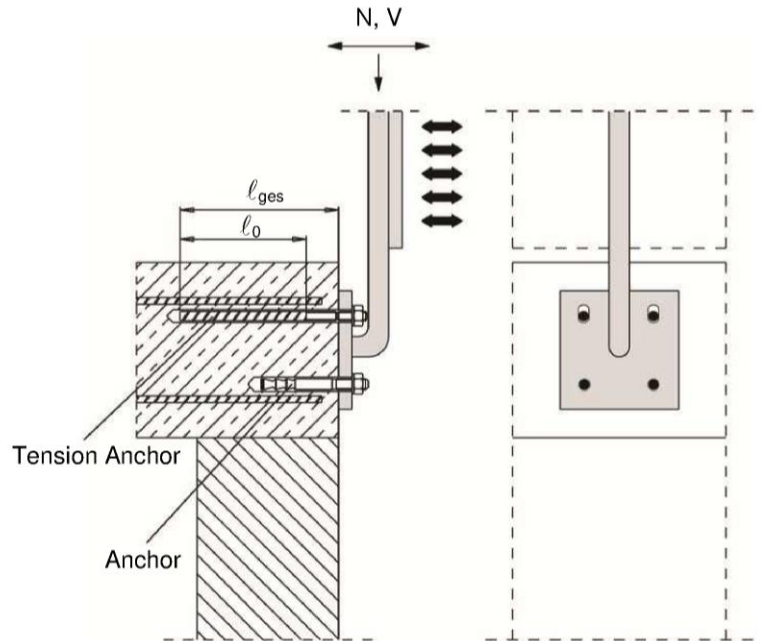

**Figure A8:** Overlap joint for the anchorage to cantilever members

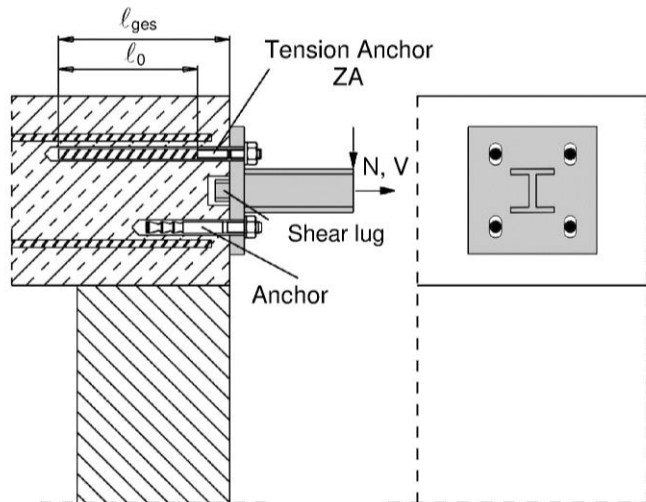

### Note to Figure A6 to A8:

In the Figures no transverse reinforcement is plotted, the transverse reinforcement shall comply with EN 1992-1-1:2002+AC:2010

Friulsider Injection System KEM-UP + Vinylester for rebar connection

### Product description

Installed condition and examples of use for tension anchors ZA

Annex A 2

### Friulsider Injection System KEM-UP + Vinylester:

#### Injection mortar: KEM-UP + Vinylester

**Typ "coaxial":** 150 ml, 280 ml,  
300 ml up to 333 ml and  
380 ml up to 420 ml cartridge

#### **Type "side-by-side":**

235 ml, 345 ml and 825 ml  
cartridge



Imprint: KEM-UP + Vinylester, processing notes, charge-code, shelf life, storage temperature, hazard-code, curing- and processing time (depending on the temperature), optional with travel scale

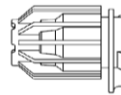

Imprint: KEM-UP + Vinylester, processing notes, charge-code, shelf life, storage temperature, hazard-code, curing- and processing time (depending on the temperature), optional with travel scale

#### Static Mixer

CRW 14W

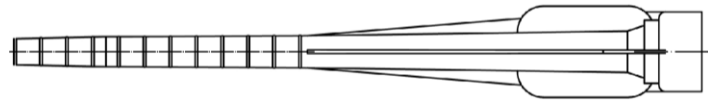

TAH 18W

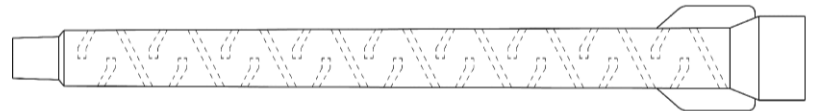

**Piston plug VS and mixer extension**



#### Reinforcing bar (rebar): $\varnothing 8$ to $\varnothing 32$



#### Tension Anchor ZA: M12 to M24

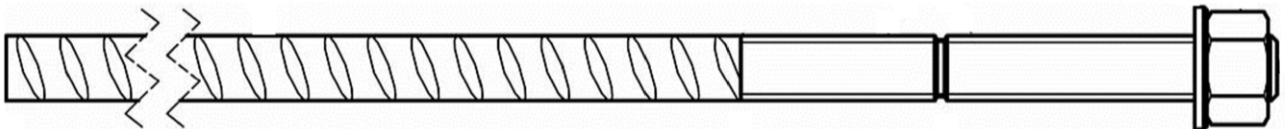

Friulsider Injection System KEM-UP + Vinylester for rebar connection

#### Product description

Injection mortar / Static mixer / Rebar / Tension Anchor ZA

**Annex A 3**

**Reinforcing bar (rebar):  $\emptyset 8, \emptyset 10, \emptyset 12, \emptyset 14, \emptyset 16, \emptyset 20, \emptyset 22, \emptyset 24, \emptyset 25, \emptyset 28, \emptyset 32$**



- Minimum value of related rip area  $f_{R,min}$  according to EN 1992-1-1:2004+AC:2010
- Rib height of the bar shall be in the range  $0,05\phi \leq h \leq 0,07\phi$   
( $\phi$ : Nominal diameter of the bar; h: Rip height of the bar)

**Table A1: Materials**

Designation	Material
Rebar EN 1992-1-1:2004+AC:2010, Annex C	Bars and de-coiled rods class B or C $f_{yk}$ and $k$ according to NDP or NCL of EN 1992-1-1/NA:2013 $f_{uk} = f_{tk} = k \cdot f_{yk}$

**Friulsider Injection System KEM-UP + Vinylester for rebar connection**

**Product description**  
Specifications Rebar

**Annex A 4**



## Tension Anchor ZA: M12, M16, M20, M24

Marking: e.g.  12 A4

 Mark of the producer  
ZA Trade name  
12 Rod diameter/thread  
A4 for stainless steel A4  
HCR for high corrosion resistance steel

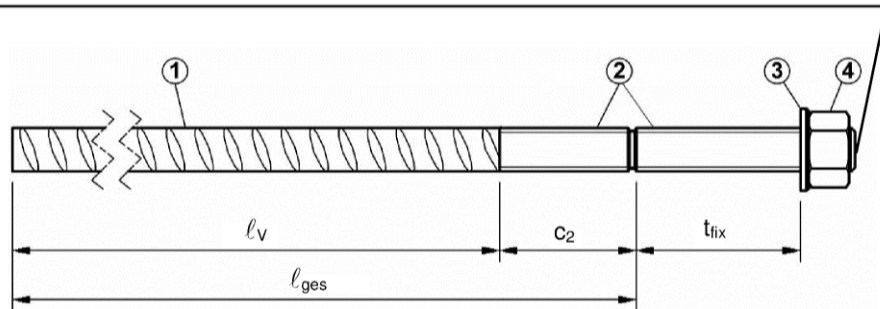

**Table A2: Materials**

Part	Designation	Material											
		ZA vz				ZA A4				ZA HCR			
		M12	M16	M20	M24	M12	M16	M20	M24	M12	M16	M20	M24
1	Reinforcement bar	Class B according to NDP or NCL of EN 1992-1-1/NA:2013 $f_{yk} = f_{tk} = k \cdot f_{yk}$											
2	Threaded rod	Steel, zinc plated according to EN 10087:1998 or EN 10263:2001				Stainless steel, 1.4362, 1.4401, 1.4404, 1.4571, EN 10088-1:2014				High corrosion resistant steel, 1.4529, 1.4565, EN 10088-1:2014			
		$f_{yk}$ [N/mm <sup>2</sup> ] 640				640				560			
3	Washer	Steel, zinc plated according to EN 10087:1998 or EN 10263:2001				Stainless steel, 1.4362, 1.4401, 1.4404, 1.4571, EN 10088-1:2014				High corrosion resistant steel, 1.4529, 1.4565, EN 10088-1:2014			
4	Nut	Steel, zinc plated according to EN 10087:1998 or EN 10263:2001				Stainless steel, 1.4362, 1.4401, 1.4404, 1.4571, EN 10088-1:2014				High corrosion resistant steel, 1.4529, 1.4565, EN 10088-1:2014			

**Table A3: Dimensions and installation parameter**

Size			ZA-M12	ZA-M16	ZA-M20	ZA-M24	
Diameter of threaded rod		[mm]	12	16	20	24	
Diameter of reinforcement bar		[mm]	12	16	20	25	
Drill hole diameter		[mm]	16	20	25	32	
Diameter of clearance hole in fixture		[mm]	14	18	22	26	
With across nut flats	SW	[mm]	19	24	30	36	
Stress area	A <sub>s</sub>	[mm <sup>2</sup> ]	84	157	245	353	
Effective embedment depth	l <sub>v</sub>	[mm]	according to static calculation				
Length of bonded thread	plated	c <sub>2</sub>	[mm]	≥ 20	≥ 20	≥ 20	≥ 20
	A4/HCR			≥ 100	≥ 100	≥ 100	≥ 100
Minimum thickness of fixture	t <sub>fix</sub>	[mm]	5	5	5	5	
Maximum thickness of fixture	t <sub>fix</sub>	[mm]	3000	3000	3000	3000	
Maximum installation torque	T <sub>max</sub>	[Nm]	50	100	150	150	

**Friulsider Injection System KEM-UP + Vinylester for rebar connection**

**Product description**  
Specifications Tension Anchor ZA

**Annex A 5**

## Specifications of intended use

### Anchorage subject to:

- Static and quasi-static loads.
- Fire exposure

### Base materials:

- Reinforced or unreinforced normal weight concrete according to EN 206-1:2000.
- Strength classes C12/15 to C50/60 according to EN 206-1:2000.
- Maximum chloride concrete of 0,40% (CL 0.40) related to the cement content according to EN 206-1:2000.
- Non-carbonated concrete.

Note: In case of a carbonated surface of the existing concrete structure the carbonated layer shall be removed in the area of the post-installed rebar connection with a diameter of  $\phi + 60$  mm prior to the installation of the new rebar.

The depth of concrete to be removed shall correspond to at least the minimum concrete cover in accordance with EN 1992-1-1:2004+AC:2010.

The foregoing may be neglected if building components are new and not carbonated and if building components are in dry conditions.

### Temperature Range:

- - 40°C to +80°C (max. short term temperature +80°C and max long term temperature +50°C).

### Use conditions (Environmental conditions):

- Structures subject to dry internal conditions or subject to external atmospheric exposure (including industrial and marine environment) and to permanently damp internal condition, if no particular aggressive conditions exist (stainless steel or high corrosion resistant steel).
- Structures subject to external atmospheric exposure and to permanently damp internal condition, if other particular aggressive conditions exist (high corrosion resistant steel).

Note: Particular aggressive conditions are e.g. permanent, alternating immersion in seawater or the splash zone of seawater, chloride atmosphere of indoor swimming pools or atmosphere with extreme chemical pollution (e.g. in desulphurization plants or road tunnels where de-icing materials are used).

### Design:

- Anchorages are designed under the responsibility of an engineer experienced in anchorages and concrete work.
- Verifiable calculation notes and drawings are prepared taking account of the forces to be transmitted.
- Design according to EN 1992-1-1:2004+AC:2010 and Annex B 2 and B 3.
- The actual position of the reinforcement in the existing structure shall be determined on the basis of the construction documentation and taken into account when designing.

### Installation:

- Dry or wet concrete.
- It must not be installed in flooded holes.
- Hole drilling by hammer drill (HD), hollow drill (HDB) or compressed air drill mode (CD).
- The installation of post-installed rebar resp. tension anchors shall be done only by suitable trained installer and under supervision on site; the conditions under which an installer may be considered as suitable trained and the conditions for supervision on site are up to the Member States in which the installation is done.
- Check the position of the existing rebars (if the position of existing rebars is not known, it shall be determined using a rebar detector suitable for this purpose as well as on the basis of the construction documentation and then marked on the building component for the overlap joint).

**Friulsider Injection System KEM-UP + Vinylester for rebar connection**

**Intended use**  
Specifications

**Annex B 1**

**Figure B1: General construction rules for post-installed rebars**

- Only tension forces in the axis of the rebar may be transmitted
- The transfer of shear forces between new concrete and existing structure shall be designed additionally according to EN 1992-1-1:2004+AC:2010.
- The joints for concreting must be roughened to at least such an extent that aggregate protrude.

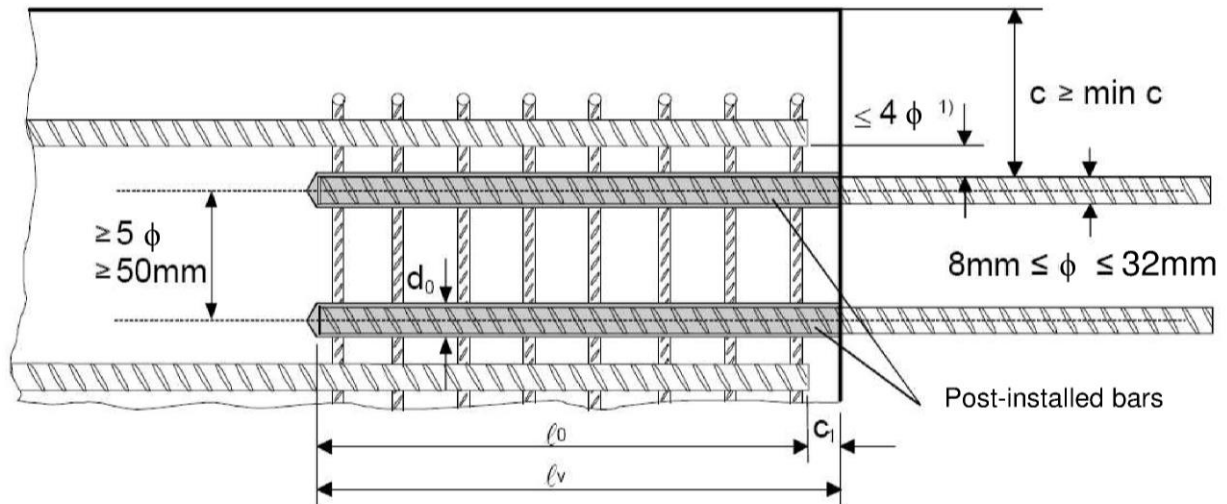

- <sup>1)</sup> If the clear distance between lapped bars exceeds  $4\phi$ , then the lap length shall be increased by the difference between the clear bar distance and  $4\phi$ .

The following applies to Figure B1:

c	concrete cover of post-installed rebar
$c_1$	concrete cover at end-face of existing rebar
min c	minimum concrete cover according to Table B1 and to EN 1992-1-1:2004+AC:2010, Section 4.4.1.2
$\phi$	diameter of post-installed rebar
$l_0$	lap length, according to EN 1992-1-1:2004+AC:2010, Section 8.7.3
$l_v$	effective embedment depth, $\geq l_0 + c_1$
$d_0$	nominal drill bit diameter, see Annex B 6

Friulsider Injection System KEM-UP + Vinylester for rebar connection

Intended use

General construction rules for post-installed rebars

Annex B 2

### Figure B2: General construction rules for tension anchors ZA

- The length of the bonded-in thread may not be accounted as anchorage
- Only tension forces in the direction of the bar axis may be transmitted by the tension anchor ZA
- The tension force must be transferred via an overlap joint to the reinforcement in the building part.
- The transfer of shear forces shall be ensured by appropriate additional measures, e.g. shear lugs or by anchors with an European technical assessment.
- In the anchor plate, the holes for the tension anchors shall be executed as elongated holes with axis in the direction of the shear force.

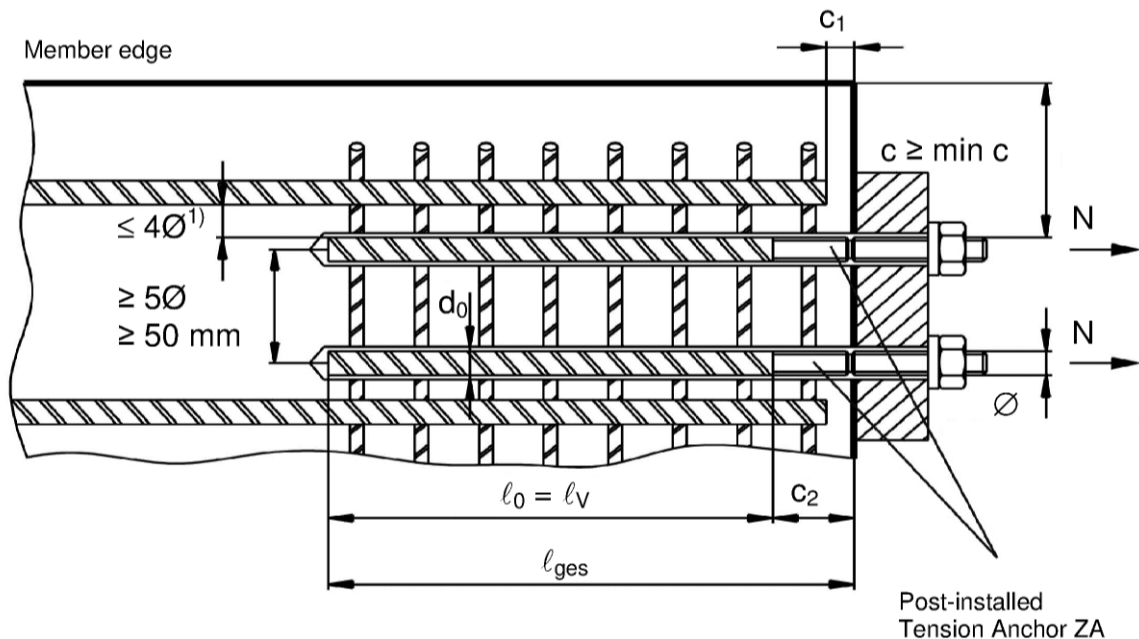

- ¹) If the clear distance between lapped bars exceeds  $4\phi$ , then the lap length shall be increased by the difference between the clear bar distance and  $4\phi$ .

The following applies to Figure B2:

$c$	concrete cover of tension anchor ZA
$c_1$	concrete cover at end-face of existing rebar
$c_2$	Length of bonded thread
min $c$	minimum concrete cover according to Table B1 and to EN 1992-1-1:2004+AC:2010, Section 4.4.1.2
$\phi$	diameter of tension anchor
$l_0$	lap length, according to EN 1992-1-1:2004+AC:2010, Section 8.7.3
$l_v$	effective embedment depth, $\geq l_0 + c_1$
$l_{ges}$	overall embedment depth, $\geq l_0 + c_2$
$d_0$	nominal drill bit diameter, see Annex B 6

Friulsider Injection System KEM-UP + Vinylester for rebar connection

Intended use  
General construction rules for tension anchors

Annex B 3

**Table B1: Minimum concrete cover  $\min c^{1)}$  of post-installed rebar depending of drilling method**

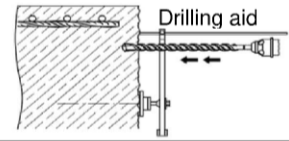

Drilling method	Rebar diameter	Without drilling aid	With drilling aid
Hammer drilling (HD)	< 25 mm	30 mm + $0,06 \cdot l_v \geq 2 \phi$	30 mm + $0,02 \cdot l_v \geq 2 \phi$
	$\geq 25$ mm	40 mm + $0,06 \cdot l_v \geq 2 \phi$	40 mm + $0,02 \cdot l_v \geq 2 \phi$
Compressed air drilling (CD)	< 25 mm	50 mm + $0,08 \cdot l_v$	50 mm + $0,02 \cdot l_v$
	$\geq 25$ mm	60 mm + $0,08 \cdot l_v$	60 mm + $0,02 \cdot l_v$

<sup>1)</sup> see Annex B2, Figures B1 and Annex B3, Figure B2  
Comments: The minimum concrete cover acc. EN 1992-1-1:2004+AC:2010 must be observed

**Table B2: maximum embedment depth  $l_{v,max}$**

Rebar	Tension anchor	$l_{v,max}$ [mm]
$\phi$	$\phi$	
8 mm		1000
10 mm		1000
12 mm	M12	1200
14 mm		1400
16 mm	M16	1600
20 mm	M20	2000
22 mm		2000
24 mm		2000
25 mm	M24	2000
28 mm		1000
32 mm		1000

**Table B3: Base material temperature, gelling time and curing time**

Concrete temperature	Gelling working time <sup>1)</sup>	Minimum curing time in dry concrete	Minimum curing time in wet concrete
-10°C to -6°C	90 min <sup>2)</sup>	24 h	48 h
-5°C to -1°C	90 min <sup>3)</sup>	14 h	28 h
0°C to +4°C	45 min <sup>3)</sup>	7 h	14 h
+5°C to +9°C	25 min <sup>3)</sup>	2 h	4 h
+10°C to +19°C	15 min <sup>3)</sup>	80 min	160 min
+20°C to +24°C	6 min <sup>3)</sup>	45 min	90 min
+25°C to +29°C	4 min <sup>3)</sup>	25 min	50 min
+30°C to +40°C	2,5 min <sup>4)</sup>	15 min	30 min

<sup>1)</sup>  $t_{gel}$ : maximum time from starting of mortar injection to completing of rebar setting.

<sup>2)</sup> Cartridge temperature **must** be at minimum +15°C

<sup>3)</sup> Cartridge temperature **must** be between +5°C and +25°C









<sup>4)</sup> Cartridge temperature **must** be below +20°C

**Friulsider Injection System KEM-UP + Vinylester for rebar connection**

**Intended use**  
Minimum concrete cover  
Maximum embedment depth / working time and curing times

**Annex B 4**

**Table B4: Dispensing tools**

Cartridge type/size	Hand tool		Pneumatic tool
Coaxial cartridges 150, 280, 300 up to 333 ml	 e.g. Type H 297 or H244C		 e.g. Type TS 492 X
Coaxial cartridges 380 up to 420 ml	 e.g. Type CCM 380/10	 e.g. Type H 285 or H244C	 e.g. Type TS 485 LX
Side-by-side cartridges 235, 345 ml	 e.g. Type CBM 330A	 e.g. Type H 260	 e.g. Type TS 477 LX
Side-by-side cartridge 825 ml	-	-	 e.g. Type TS 498X

All cartridges could also be extruded by a battery tool.

**Friulsider Injection System KEM-UP + Vinylester for rebar connection**

**Intended Use**  
Dispensing tools

**Annex B 5**

### A) Bore hole drilling

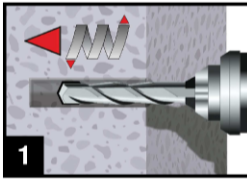

1. Drill a hole into the base material to the size and embedment depth required by the selected reinforcing bar with carbide hammer drill (HD) or a compressed air drill (CD). In case of aborted drill hole: the drill hole shall be filled with mortar.



Hammer drill (HD)  
Hollow drill (HDB)

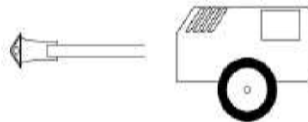

Compressed air drill (CD)

Rebar - $\phi$	ZA- $\phi$	Drill - $\phi$ [mm]
8 mm		12
10 mm		14
12 mm	M12	16
14 mm		18
16 mm	M16	20
20 mm	M20	25
22 mm		28
24 mm		32
25 mm	M24	32
28 mm		35
32 mm		40

### B) Bore hole cleaning (HD, HDB and CD)

**MAC: Cleaning for bore hole diameter  $d_0 \leq 20\text{mm}$  and bore hole depth  $h_0 \leq 10d_s$**

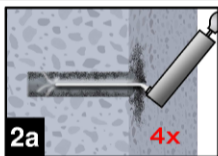

- 2a. Starting from the bottom or back of the bore hole, blow the hole clean a hand pump (Annex B 7) a minimum of four times.

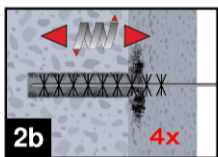

- 2b. Check brush diameter (Table B5). Brush the hole with an appropriate sized wire brush  $> d_{b,min}$  (Table B5) a minimum of four times in a twisting motion. If the bore hole ground is not reached with the brush, a brush extension shall be used.

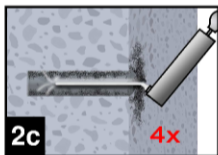

- 2c. Finally blow the hole clean again with a hand pump (Annex B 7) a minimum of four times.

**CAC: Cleaning for all bore hole diameter and bore hole depth**

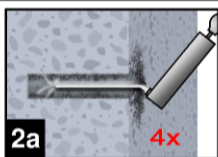

- 2a. Starting from the bottom or back of the bore hole, blow the hole clean with compressed air (min. 6 bar) (Annex B 7) a minimum of four times until return air stream is free of noticeable dust. If the bore hole ground is not reached an extension shall be used.

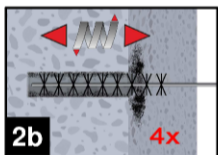

- 2b. Check brush diameter (Table B5). Brush the hole with an appropriate sized wire brush  $> d_{b,min}$  (Table B5) a minimum of four times. If the bore hole ground is not reached with the brush, a brush extension shall be used (Table B5).

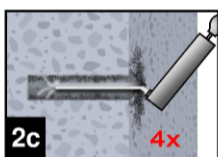

- 2c. Finally blow the hole clean again with compressed air (min. 6 bar) (Annex B 7) a minimum of four times until return air stream is free of noticeable dust. If the bore hole ground is not reached an extension shall be used.

**Friulsider Injection System KEM-UP + Vinylester for rebar connection**

**Intended Use**

Installation instruction: Bore hole drilling and  
Bore hole cleaning

**Annex B 6**

**Table B5: Cleaning tools**

Brush RBT:

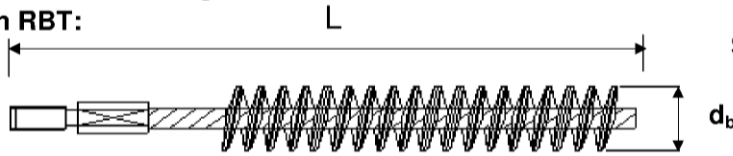

SDS Plus Adapter:



Brush extension:



$\phi$ Rebar (mm)	$\phi$ Tension anchor (mm)	$d_0$ Drill bit - $\phi$ (mm)	$d_b$ Brush - $\phi$ (mm)		$d_{b,min}$ min. Brush - $\phi$ (mm)
8		12	RBT12	14	12,5
10		14	RBT14	16	14,5
12	M12	16	RBT16	18	16,5
14		18	RBT18	20	18,5
16	M16	20	RBT20	22	20,5
20	M20	25	RBT25	27	25,5
22		28	RBT28	30	28,5
24		32	RBT32	34	32,5
25	M24	32	RBT32	34	32,5
28		35	RBT35	37	35,5
32		40	RBT40	41,5	40,5



Hand pump (volume 750 ml)



Rec. compressed air tool  
hand slide valve (min 6 bar)

**C) Preparation of bar and cartridge**

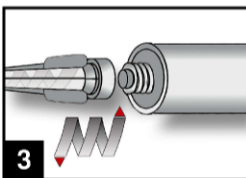

- Attach the supplied static-mixing nozzle to the cartridge and load the cartridge into the correct dispensing tool.  
For every working interruption longer than the recommended working time (Table B3) as well as for every new cartridges, a new static-mixer shall be used.

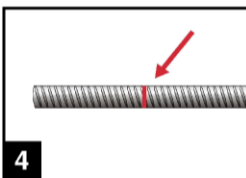

- Prior to inserting the reinforcing bar into the filled bore hole, the position of the embedment depth shall be marked (e.g. with tape) on the reinforcing bar and insert bar in empty hole to verify hole and depth  $l_v$ .  
The reinforcing bar should be free of dirt, grease, oil or other foreign material.

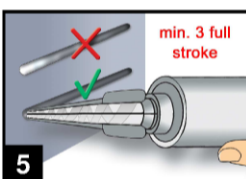

- Prior to dispensing into the anchor hole, squeeze out separately the mortar until it shows a consistent grey colour, but a minimum of three full strokes, and discard non-uniformly mixed adhesive components.

**Friulsider Injection System KEM-UP + Vinylester for rebar connection**

**Intended Use**

Installation instruction: Cleaning tools and  
Preparation of bar and cartridge

**Annex B 7**



## D) Filling the bore hole

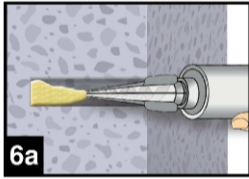

6. Starting from the bottom or back of the cleaned anchor hole fill the hole up to approximately two-thirds with adhesive. Slowly withdraw the static mixing nozzle as the hole fills to avoid creating air pockets. For embedment larger than 190 mm an extension nozzle shall be used.

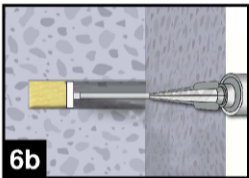

For overhead and horizontal installation and bore holes deeper than 240 mm a piston plug and the appropriate mixer extension must be used.

Observe the gel-/ working times given in Table B3.

**Table B6: Piston plugs, max anchorage depth and mixer extension**

Bar size $\phi$ [mm]	Tension anchor $\phi$ [mm]	Drill bit - $\phi$ [mm]		Piston plug	Cartridge: All sizes				Cartridge: side-by-side (825 ml)		
		HD, HDB	CD		Hand or battery tool		Pneumatic tool		Pneumatic tool		
					$l_{v,max}$ [cm]	Mixer extension	$l_{v,max}$ [cm]	Mixer extension	$l_{v,max}$ [cm]	Mixer extension	
8		12	-	-	70	VL 10/0,75	VL 10/0,75	VL 10/0,75	80	80	
10		14	VS14	VS14					100	100	100
12	M12	16		VS16					100	100	120
14		18		VS18					100	100	140
16	M16	20		VS20					100	100	160
20	M20	25	VS25	VS25	50	VL 10/0,75	VL 10/0,75	VL 16/1,8	200	200	
22		28		VS28					70	70	200
24		32		VS32					50	50	200
25	M24	32		VS32					50	50	200
28		35		VS35					50	50	200
32		40		VS40					50	50	200

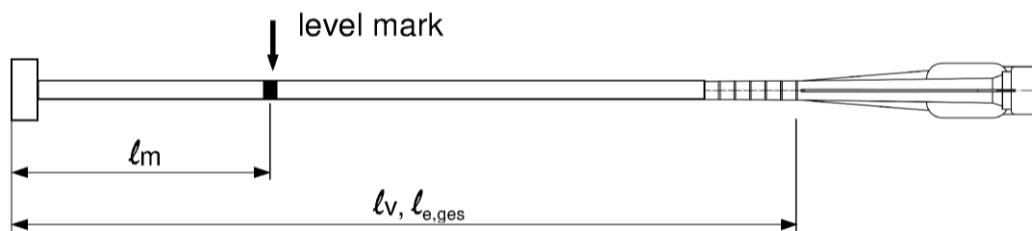

Injection tool must be marked by mortar level mark  $l_m$  and anchorage depth  $l_v$  resp.  $l_{e,ges}$  with tape or marker.

Quick estimation:  $l_m = 1/3 \cdot l_v$

Continue injection until the mortar level mark  $l_m$  becomes visible.

Optimum mortar volume:  $l_m = l_v$  resp.  $l_{e,ges} \cdot \left( 1,2 \cdot \frac{\phi^2}{d_0^2} - 0,2 \right)$  [mm]

**Friulsider Injection System KEM-UP + Vinylester for rebar connection**

**Intended Use**

Installation instruction: Filling the bore hole

**Annex B 8**

## E) Inserting the rebar

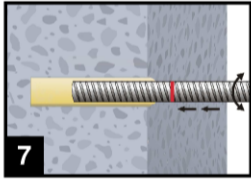

7. Push the reinforcing bar into the anchor hole while turning slightly to ensure positive distribution of the adhesive until the embedment depth is reached.

The bar should be free of dirt, grease, oil or other foreign material.

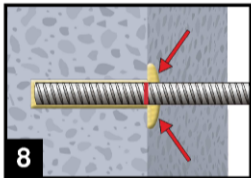

8. Be sure that the bar is inserted in the bore hole until the embedment mark is at the concrete surface and that excess mortar is visible at the top of the hole. If these requirements are not maintained, the application has to be renewed. For overhead installation fix embedded part (e.g. wedges).

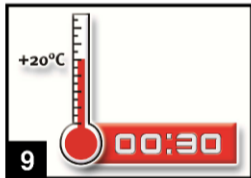

9. Observe gelling time  $t_{gel}$ . Attend that the gelling time can vary according to the base material temperature (see Table B3). It is not allowed to move the bar after gelling time  $t_{gel}$  has elapsed. Allow the adhesive to cure to the specified time prior to applying any load. Do not move or load the bar until it is fully cured (attend Table B3). After full curing time  $t_{cure}$  has elapsed, the add-on part can be installed.

Friulsider Injection System KEM-UP + Vinylester for rebar connection

### Intended Use

Installation instruction: Inserting rebar

Annex B 9

### Minimum anchorage length and minimum lap length

The minimum anchorage length  $\ell_{b,min}$  and the minimum lap length  $\ell_{0,min}$  according to EN 1992-1-1:2004+AC:2010 ( $\ell_{b,min}$  acc. to Eq. 8.6 and Eq. 8.7 and  $\ell_{0,min}$  acc. to Eq. 8.11) shall be multiply by the amplification factor  $\alpha_{4b}$  according to Table C1.

**Table C1: Amplification factor  $\alpha_{4b}$  related to concrete class and drilling method**

Concrete class	Drilling method	Bar size	Amplification factor $\alpha_{4b}$
C12/15 to C50/60	Hammer drilling (HD), hollow drilling (HDB) and compressed air drilling (CD)	8 mm to 32 mm ZA-M12 to ZA-M24	1,0

**Table C2: Design values of the ultimate bond stress  $f_{bd}$  in N/mm<sup>2</sup> for all drilling methods for good conditions**

according to EN 1992-1-1:2004+AC:2010 for good bond conditions  
(for all other bond conditions multiply the values by 0.7)

Rebar - $\varnothing$	Concrete class								
	C12/15	C16/20	C20/25	C25/30	C30/37	C35/45	C40/50	C45/55	C50/60
$\phi$									
8 to 25 mm ZA-M12 to ZA-M24	1,6	2,0	2,3	2,7	3,0	3,4	3,7	4,0	4,3
28 to 32 mm	1,6	2,0	2,3	2,7	3,0	3,4	3,7	3,7	3,7

Friulsider Injection System KEM-UP + Vinylester for rebar connection

**Performances**

Amplification factor  $\alpha_{4b}$   
Design values of ultimate bond resistance  $f_{bd}$

**Annex C 1**

### Design value of the ultimate bond stress $f_{bd,fi}$ under fire exposure for concrete classes C12/15 to C50/60, (all drilling methods):

The design value of the bond strength  $f_{bd,fi}$  under fire exposure has to be calculated by the following equation:

$$f_{bd,fi} = k_{b,fi}(\theta) \cdot f_{bd} \cdot \gamma_c / \gamma_{M,fi}$$

with:  $\theta \leq 243^\circ\text{C}$ :  $k_{b,fi}(\theta) = 18,88 \cdot e^{(\theta \cdot -0,016)} / (f_{bd} \cdot 4,3) \leq 1,0$   
 $\theta > 243^\circ\text{C}$ :  $k_{b,fi}(\theta) = 0$

- $f_{bd,fi}$  Design value of the ultimate bond stress in case of fire in N/mm<sup>2</sup>
- $\theta$  Temperature in °C in the mortar layer.
- $k_{b,fi}(\theta)$  Reduction factor under fire exposure.
- $f_{bd}$  Design value of the ultimate bond stress in N/mm<sup>2</sup> in cold condition according to Table C2 considering the concrete classes, the rebar diameter, the drilling method and the bond conditions according to EN 1992-1-1.
- $\gamma_c$  partially safety factor according to EN 1992-1-1
- $\gamma_{M,fi}$  partially safety factor according to EN 1992-1-2

For evidence under fire exposure the anchorage length shall be calculated according to EN 1992-1-1:2004+AC:2010 Equation 8.3 using the temperature-dependent ultimate bond stress  $f_{bd,fi}$ .

### Example graph of Reduction factor $k_{b,fi}(\theta)$ for concrete classes C20/25 for good bond conditions:

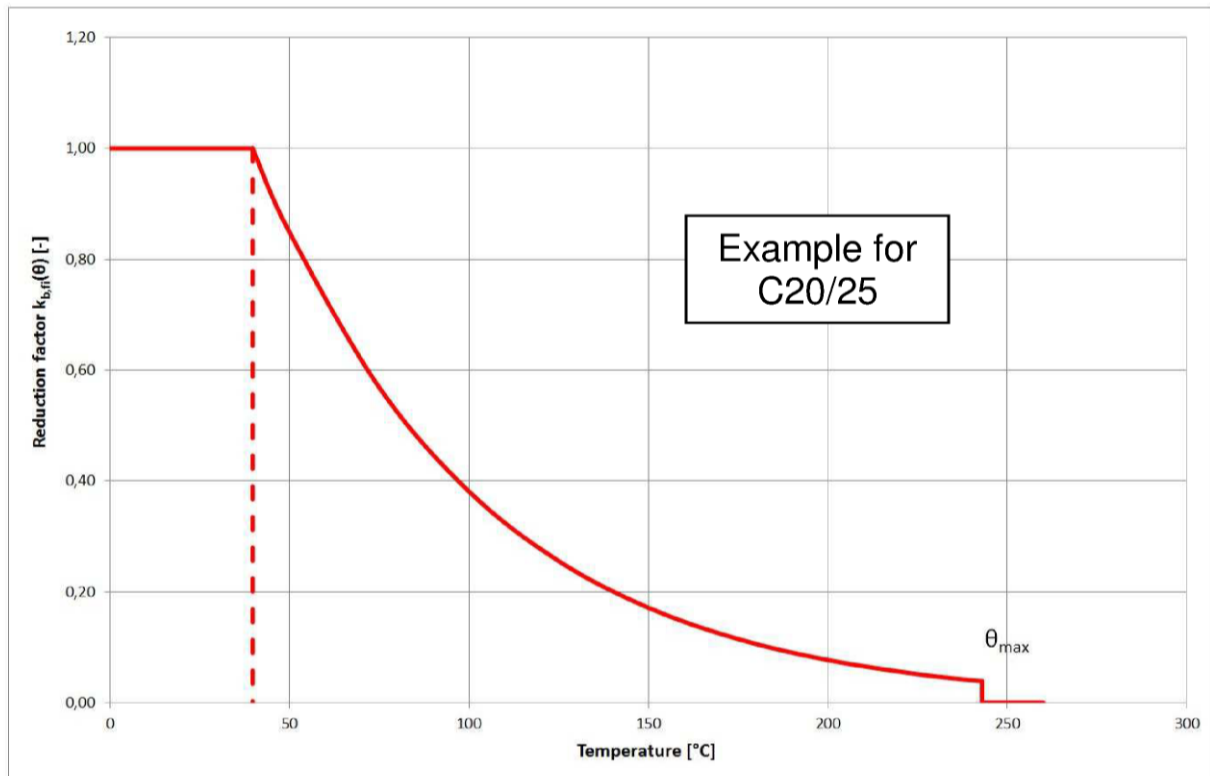

Friulsider Injection System KEM-UP + Vinylester for rebar connection

#### Performances

Design value of bond strength  $f_{bd,fi}$  under fire exposure

Annex C 2

**Table C3: Characteristic tension strength for tension anchor ZA under fire exposure,**  
concrete classes C12/15 to C50/60, according to Technical Report TR 020

Tension Anchor				M12	M16	M20	M24
Steel, zinc plated (ZA vz)							
Characteristic steel strength	R30	$\sigma_{Rk,s,fi}$	[N/mm <sup>2</sup> ]	20			
	R60			15			
	R90			13			
	R120			10			
Stainless Steel (ZA A4 or ZA HCR)							
Characteristic steel strength	R30	$\sigma_{Rk,s,fi}$	[N/mm <sup>2</sup> ]	30			
	R60			25			
	R90			20			
	R120			16			

**Design value of the steel strength  $\sigma_{Rd,s,fi}$  under fire exposure**

The design value of the steel strength  $\sigma_{Rd,s,fi}$  under fire exposure has to be calculated by the following equation:

$$\sigma_{Rd,s,fi} = \sigma_{Rk,s,fi} / \gamma_{M,fi}$$

with:

$\sigma_{Rk,s,fi}$  characteristic steel strength according to Table C3

$\gamma_{M,fi}$  partially safety factor according to EN 1992-1-2

**Friulsider Injection System KEM-UP + Vinylester for rebar connection**

**Performances**

Design value of the steel strength  $\sigma_{Rd,s,fi}$  for tension anchor ZA under fire exposure

**Annex C 3**